

PRODUCT CATALOGUE
2009

MARBETT®
CONVEYOR COMPONENTS
SUPPORTING AND LEVELLING ELEMENTS
SELF-ALIGNING BEARINGS



FlatTop Europe

REXNORD
PRECISION. POWER. PERFORMANCE.

Compact pillow block

UCPA/C - HCPA/C



- **Waterproof housing**
- **Grub screws or eccentric collar shaft locking**
- **PA FV polyamide housing**
High mechanical and heat resistance.
Proof to dust, humidity, washouts, steam, average aggressive chemical agents.
- **PP FV polypropylene housing**
Proof to highly aggressive chemical agents.
Inferior loading ability.
- **Supports with Microban® antibacterial protection**
Microban® material is effective against the most common bacteria that may grow in foodstuff like E. Coli, Salmonella, Listeria, S-Aureus, Campylobacter.

Material

PA FV polyamide housing

- Housing in reinforced polyamide PA FV resin (black)
- Protection cover in polypropylene PP (orange) with Microban®
- Seal and O-Ring in NBR rubber (black)
- Ball type nickel plated brass greasing nipple
- Nickel plated brass threaded bushings.

PA FV polyamide housing with Microban®

- Housing in reinforced polyamide PA FV resin (blue) with Microban®
- Protection cover in polypropylene PP (orange) with Microban®
- Seal and O-Ring in NBR rubber (black)
- Ball type nickel plated brass greasing nipple
- Nickel plated brass threaded bushings.

PP FV polypropylene housing with Microban®

- Housing in reinforced polypropylene PP FV resin (white) with Microban®
- Protection cover in polypropylene PP (orange) with Microban®
- Seal and O-Ring in NBR rubber (black).
On request supplied in Viton rubber (brown).
Viton material offers high resistance to chemical agents
- Ball type stainless steel AISI 316 greasing nipple
- Nickel plated brass threaded bushings.

Continuous operating temperature

in air : - 20 to + 60°C.

Maximum allowed misalignment : 2°.

Bearing



- Series YAT (grub screws shaft locking)
- Series YET (eccentric collar shaft locking)
- Chrome alloy steel
- Superagriseal unit
- Prelubricated with lithium / calcium grease
- Can be relubricated.

Series UCPA/C Grub screws shaft locking

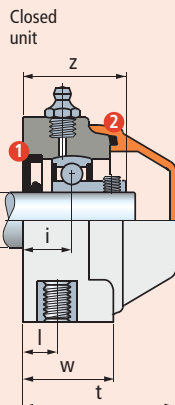

Series HCPA/C Eccentric collar shaft locking

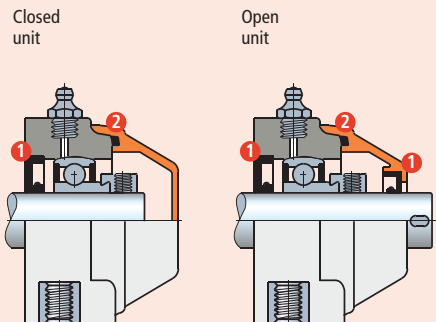

- 1 Seal.
- 2 O-Ring.

dia. d mm	Series	Housing material			Dimensions in mm											Weight Kg	Spare parts Cover orange Code
		Polyamide PA FV Flange (black) Cover (orange)	Polyamide PA FV with Microban® Flange (blue) Cover (orange)	Polypropylene PP FV with Microban® Flange (white) Cover (orange)	e	a	h	b	s	w	i	l	z	t	Bearing		
Grub screws shaft locking • Closed unit																	
17	UCPA 203 C	696182	696302	696542	47	70	30,2	62	M8	28	15,2	10	31,1	49	YAT 203	0,22	681942
20	UCPA 204 C	696192	696312	696552	50,8	70	33,2	65	M8	28	15,2	10	33,5	49	YAT 204	0,25	681942
25	UCPA 205 C	696202	696322	696562	50,8	75	36,5	72	M10	30	16,8	12	36,3	52	YAT 205	0,29	681952
Grub screws shaft locking • Open unit																	
17	UCPA 203 C	696212	696332	696572	47	70	30,2	62	M8	28	15,2	10	31,1	49	YAT 203	0,22	696162
20	UCPA 204 C	696222	696342	696582	50,8	70	33,2	65	M8	28	15,2	10	33,5	49	YAT 204	0,25	681962
25	UCPA 205 C	696232	696352	696592	50,8	75	36,5	72	M10	30	16,8	12	36,3	52	YAT 205	0,29	681972
Eccentric collar shaft locking • Closed unit																	
17	HCPA 203 C	696242	696362	696602	47	70	30,2	62	M8	28	15,2	10	37,3	49	YET 203	0,24	681942
20	HCPA 204 C	696252	696372	696612	50,8	70	33,2	65	M8	28	15,2	10	38,7	49	YET 204	0,27	681942
25	HCPA 205 C	696262	696382	696622	50,8	75	36,5	72	M10	30	16,8	12	40,3	52	YET 205	0,34	681952
Eccentric collar shaft locking • Open unit																	
17	HCPA 203 C	696272	696392	696632	47	70	30,2	62	M8	28	15,2	10	37,3	49	YET 203	0,24	696162
20	HCPA 204 C	696282	696402	696642	50,8	70	33,2	65	M8	28	15,2	10	38,7	49	YET 204	0,27	681962
25	HCPA 205 C	696292	696412	696652	50,8	75	36,5	72	M10	30	16,8	12	40,3	52	YET 205	0,34	681972

Item code for order = B0000 + Code

Packaging : 6 pieces.

Compact pillow block

UCPA - HCPA



Accessories



Material

PA FV polyamide housing

- Housing in reinforced polyamide PA FV resin (black)
- Ball type nickel plated brass greasing nipple
- Nickel plated brass threaded bushings.

PA FV polyamide housing with Microban®

- Housing in reinforced polyamide PAFV resin (blue) with Microban®
- Ball type nickel plated brass greasing nipple
- Nickel plated brass threaded bushings.

PP FV polypropylene housing with Microban®

- Housing in reinforced polypropylene PP FV resin (white) with Microban®
- Ball type stainless steel AISI 316 greasing nipple
- Nickel plated brass threaded bushings.

Continuous operating temperature

in air : - 20 to + 60°C.

Maximum allowed misalignment : 2°.

Bearing

- Series YAR 2F (grub screws shaft locking, chrome alloy steel, Supergriseal unit plus centrifuging ring)
- Series YAR 2RF (grub screws shaft locking, stainless steel AISI 420, Supergriseal unit plus rubberised centrifuging ring)
- Series YAT (grub screws shaft locking, chrome alloy steel, Supergriseal unit)
- Series YET (eccentric collar shaft locking, chrome alloy steel, Supergriseal unit)
- Prelubricated with lithium / calcium grease • Can be relubricated.

Version with bearing YAR 2F

The double ring guarantees maximum protection against dust and non-corrosive substances.

Version with stainless steel bearing YAR 2RF

AISI 420 stainless steel bearing with 2 rubberised rings, provides excellent seal against humidity, steams, liquids, medium corrosive chemical agents. Maximum load ability is inferior.

Version with bearing YAT

The rubberised ring guarantees maximum protection against dusts.

Supports with Microban® antibacterial protection

Microban® material is effective against the most common bacteria that may grow in foodstuff like E. Coli, Salmonella, Listeria, S-Aureus, Campylobacter.

Material

Polyamide PA FV guarantees maximum strength and high-temperature resistance.

Polypropylene PP FV offers excellent resistance to chemical agents but inferior load ability.

Protection covers (accessories)

Closed cover

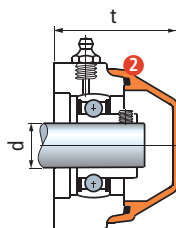

Open cover

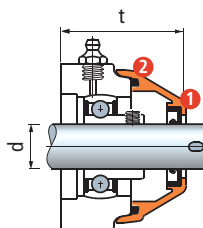

- 1 Seals
- 2 Seals O-Ring

dia. d mm	Accessories		t mm
	Cover orange	Code	
Closed cover supplied with seals			
17	681942		49
20	681942		49
25	681952		52
Open cover supplied with seals			
17	696162		49
20	681962		49
25	681972		52

Series UCPA Grub screws shaft locking

Version with bearing YAR 2F

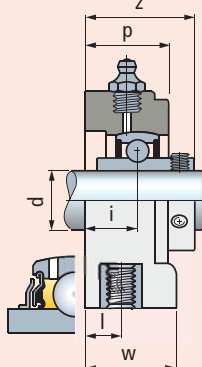

Version with bearing YAR 2RF

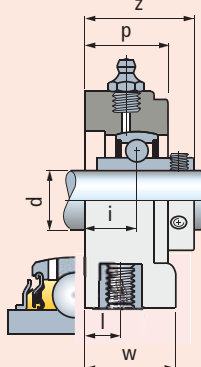

Version with bearing YAT

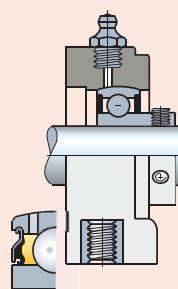

Series HCPA Eccentric collar shaft locking

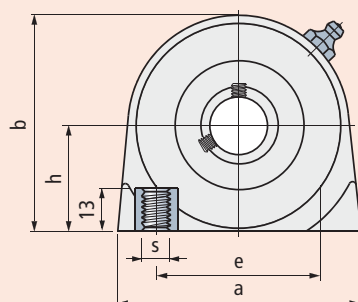
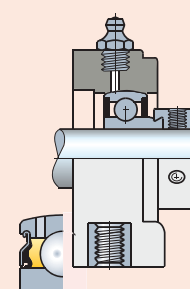

dia. d mm	Series	Housing material			Dimensions in mm											Weight Kg
		Polyamide PA FV Flange (black)	Polyamide PA FV with Microban® Flange (blue)	polypropylene PP FV with Microban® Flange (white)	e	a	h	b	s	w	i	l	z	p	Bearing	
		Code														
Grub screws shaft locking • Version with bearing YAR 2F																
17	UCPA 203	696902	-	-	47	70	30,2	62	M8	28	15,2	10	31,1	27	YAR 203 F	0,21
20	UCPA 204	696912	-	-	50,8	70	33,2	65	M8	28	15,2	10	33,5	27	YAR 204 F	0,26
25	UCPA 205	696922	-	-	50,8	75	36,5	72	M10	30	16,8	12	36,5	30	YAR 205 F	0,30
Grub screws shaft locking • Version with stainless steel bearing YAR 2RF																
20	UCPA 204	696942	696972	697002	50,8	70	33,2	65	M8	28	15,2	10	33,5	27	YAR 204 RF	0,26
25	UCPA 205	696952	696982	697012	50,8	75	36,5	72	M10	30	16,8	12	36,5	30	YAR 205 RF	0,30
Grub screws shaft locking • Version with bearing YAT																
17	UCPA 203	696662	696722	696842	47	70	30,2	62	M8	28	15,2	10	31,1	27	YAT 203	0,21
20	UCPA 204	696672	696732	696852	50,8	70	33,2	65	M8	28	15,2	10	33,5	27	YAT 204	0,24
25	UCPA 205	696682	696742	696862	50,8	75	36,5	72	M10	30	16,8	12	36,5	30	YAT 205	0,28
Eccentric collar shaft locking																
17	HCPA 203	696692	696752	696872	47	70	30,2	62	M8	28	15,2	10	37,3	27	YET 203	0,23
20	HCPA 204	696702	696762	696882	50,8	70	33,2	65	M8	28	15,2	10	38,7	27	YET 204	0,26
25	HCPA 205	696712	696772	696892	50,8	75	36,5	72	M10	30	16,8	12	40,3	30	YET 205	0,33

Item code for order = B0000 + Code

Packaging : 6 pieces.

AUSTRALIA

Rexnord Australia Pty. Ltd.
Picton, New South Wales
Phone: 61-2-4677-3811
Fax: 61-2-4677-3812

BRAZIL

Rexnord Correntes Ltda.
Sao Leopoldo - RS
Phone: 55-51-579-8022
Fax: 55-51-579-8029

CANADA

Rexnord Canada Ltd.
Scarborough, Ontario
Phone: 1-416-297-6868
Fax: 1-416-297-6873

CHINA

Rexnord China
Shanghai
Phone: 86-21-62701942
Fax: 86-21-62701943

FLATTOP EUROPE

Rexnord FlatTop Europe b.v.
's-Gravenzande, The Netherlands
Phone: 31-174-445-111
Fax: 31-174-445-222

Rexnord Marbett S.r.L.
Correggio (RE), Italy
Phone: 39-0522-639333
Fax: 39-0522-637778

UNITED STATES

Customer Service
Phone: 1-866-REXNORD
(1-866-739-6673)
Fax: 1-614-675-1898
E-mail: rexnordcs(state)@rexnord.com
Example: rexnordcsohio@rexnord.com

Rexnord FlatTop North America
Grafton, Wisconsin
Phone: 1-262-376-4700
Fax: 1-262-376-4720

Rexnord International - Power Transmission
Milwaukee, Wisconsin
Phone: 1-414-643-2366
Fax: 1-414-643-3222
E-mail: international2@rexnord.com

ALL COUNTRIES NOT LISTED

Rexnord FlatTop Europe b.v.
's-Gravenzande, The Netherlands
Phone: 31-174-445-111
Fax: 31-174-445-222

After Hours/Emergency Phone:
31-174-445-112



www.rexnordflattop.com
flattopeurope@rexnord.com